

Venusun^S

& Balkonkraftwerk Set

**390-410W Transparente Folie
Maßgeschneidert für Balkonkraftwerk**



INHALTE

01

Installationsorte

02

**Unsere besseren
Lösungen**

03

**Unser Zertifikat und
Garantie**

04

Unsere Fabrik

01 Installationsorte



Garten & Hof

Balkon und hauswand

01 Installationsorte

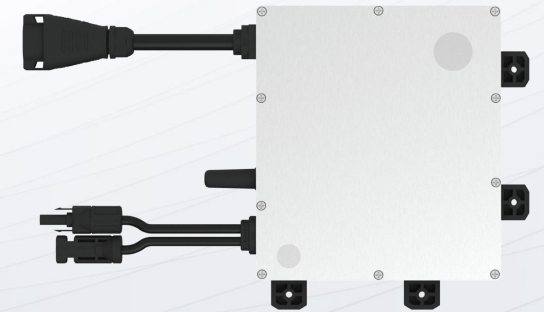
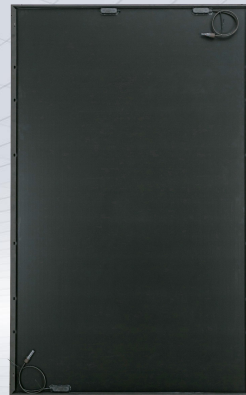

Leichtes Gewicht:
Niedrige Transportkosten
und einfache Installation



Transparente Folie:
Bifaziale Stromerzeugung



Ordentliche Kabel:
versteckt in der Rückseite



weniger Zeitaufwand
Mikro-Wechselrichter werden
schon an Module montiert

02 Unsere besseren Lösungen



Reduziertes Gewicht

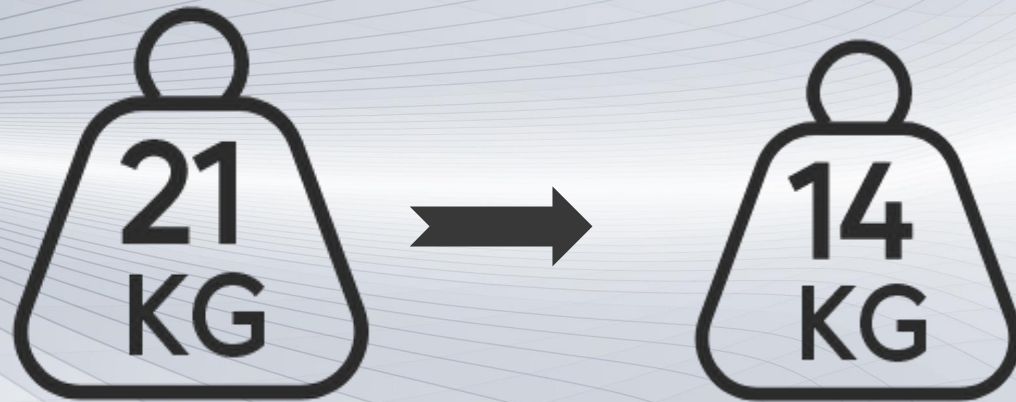

Ein einziges Solarmodul reduziert das Gewicht von 21 kg auf 14 kg

3,2 mm Glas >>> 1,6 mm Glas



Leichterer Transport und einfachere Installation

Transparente Folie



Schwarze Folie



Transparente Folie

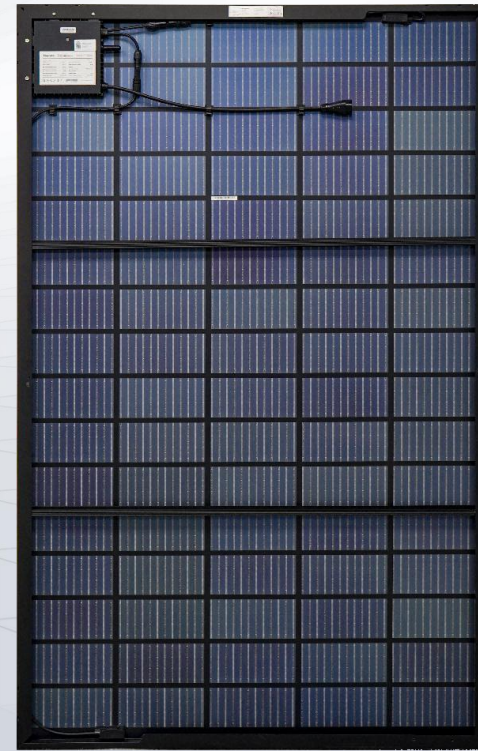

5-20 % zusätzlicher Ertrag



Ordentliche Kabel nach der Installation

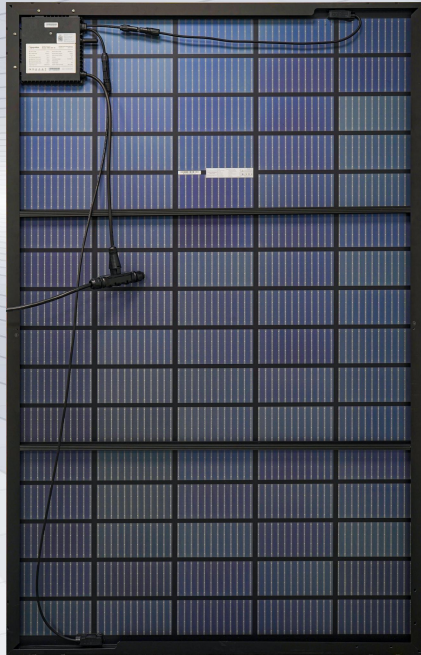

Unordentliche Kabel nach der Montage

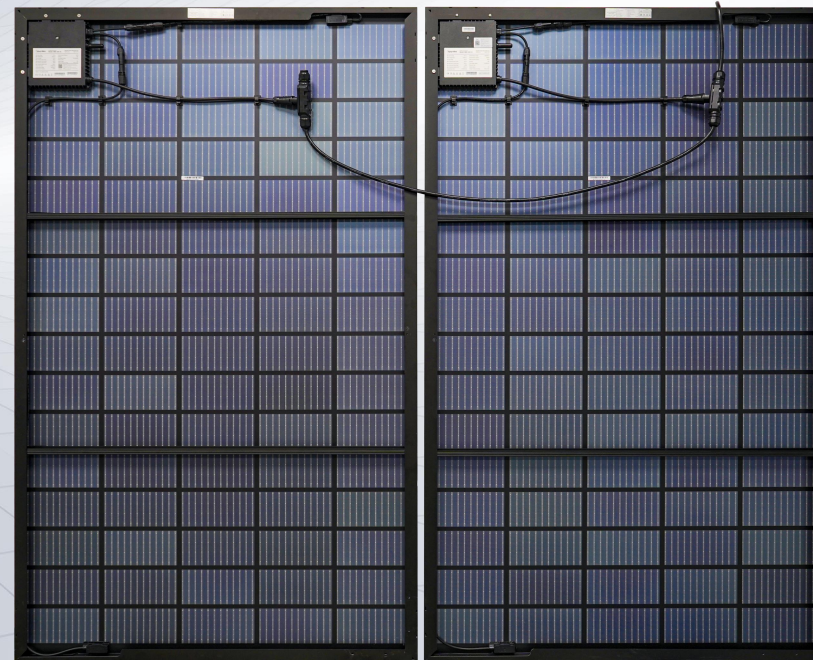

Ordentliche Kabel nach der Installation

**Mit Kabelschellen sieht das
Venusun-Balkonkraftwerk
ordentlich aus**

App Überwachung

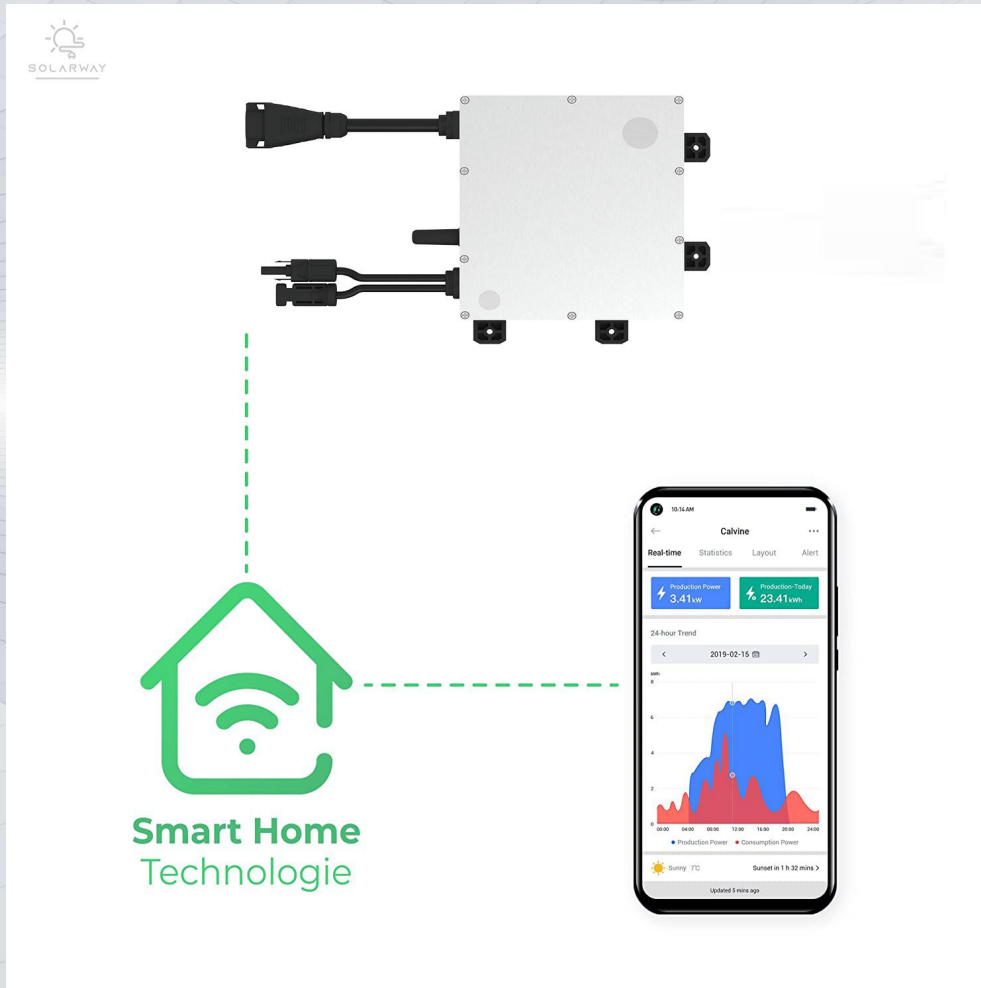

App-Echtzeitüberwachung

Besseres Aussehen

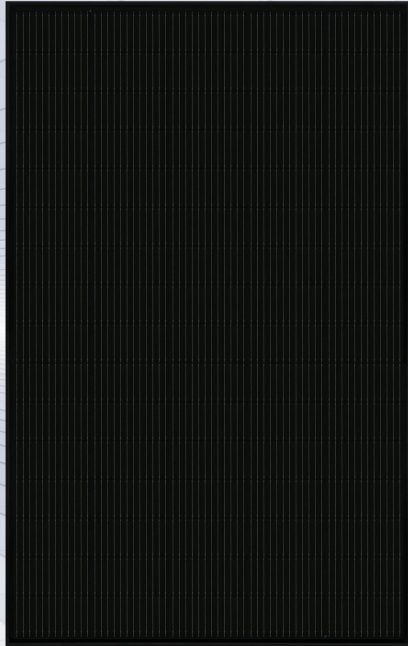

Vorderseite

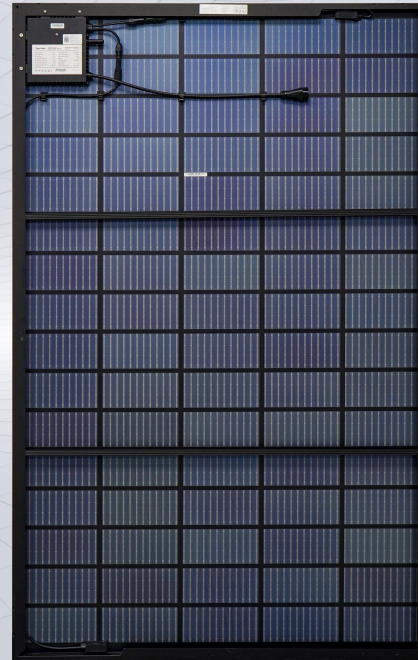

Rückseite

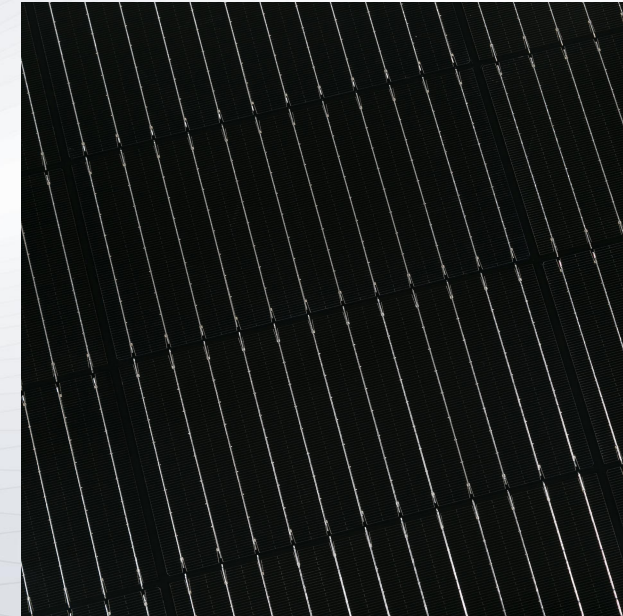

Einzelheiten

Schwarzes Erscheinungsbild und transparente Rückwand

Venusun S sieht noch schöner aus

Mikro-Wechselrichter

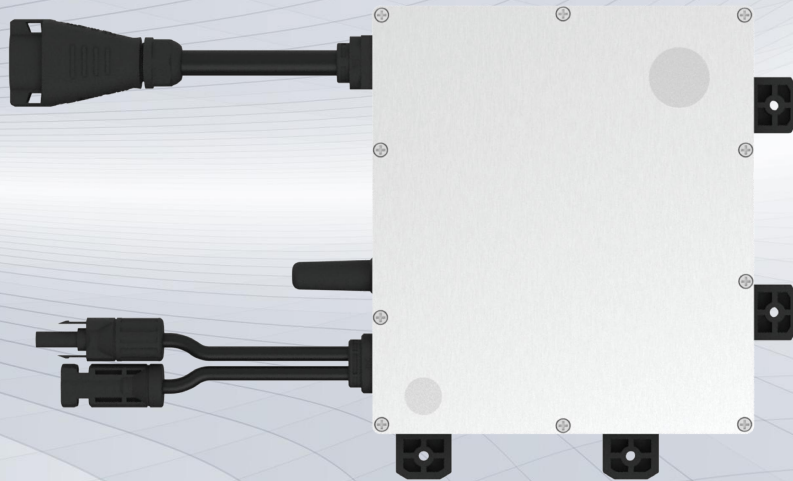

Funktionen des Mikro-Wechselrichters: **1. MPPT (Max Power Point Tracking=Maximale Leistungspunktverfolgung)**
2. Hohe Zuverlässigkeit, Gehäuse IP67 (NEMA 6),
6000 V Überspannungsschutz
3. Mit Blindleistungsregelung, konform mit
VDE-AR-N 4105: 2018 & EN 50549-1: 2019
4. Externe Antenne für stärkere Kommunikation mit DTU

Mit der App-Überwachung können Benutzer die Stromerzeugung besser ermitteln

Hohe Zuverlässigkeit



Venusun S verfügt über die Brandschutzklasse C und ist für alle Wetter und Bedingungen geeignet.

Unser BKW Set

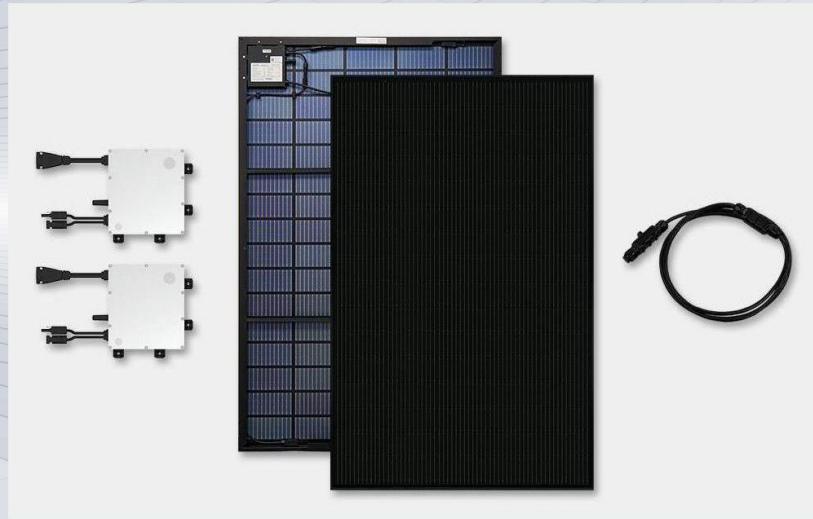

Ein komplettes Solarsystem mit:

2 Stück Solarmodule

2 Stück Hoymiles 400W Mikro-Wechselrichter

2 T-Stecker und 5 m Kabel

03 Unsere Garantie



12 Jahre Produktgarantie

25 Jahre Leistungsgarantie

10 Jahre Stromerzeugung $\geq 92\%$

20 Jahre Stromerzeugung $\geq 82\%$

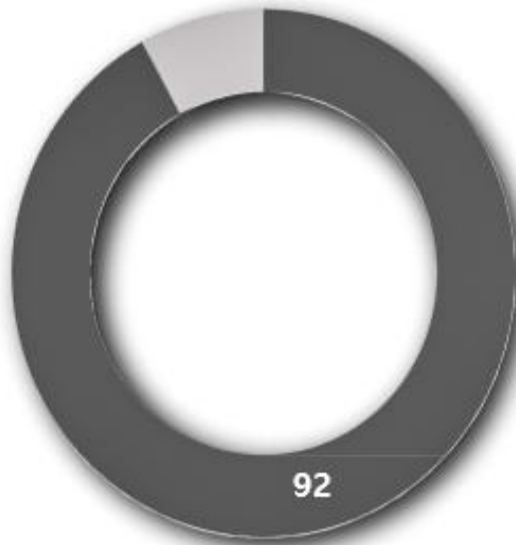

92%

10 years power generation $\geq 92\%$

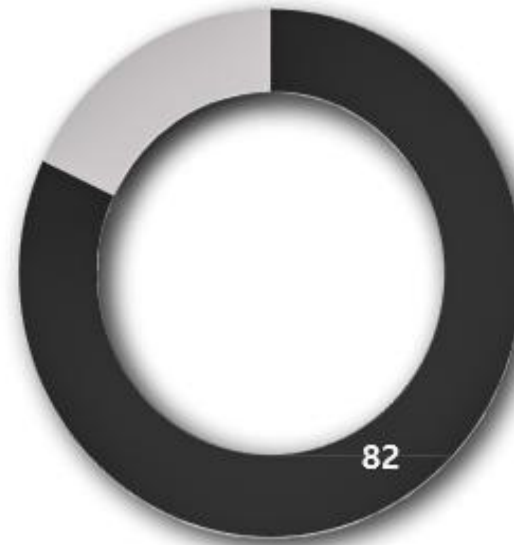

82%

20 years of power generation $\geq 82\%$

04 Unsere Fabrik



Factory



Dankeschön



Maysun Solar

